

Kawasaki Zx-6R, Zx-9R (1998-2003)

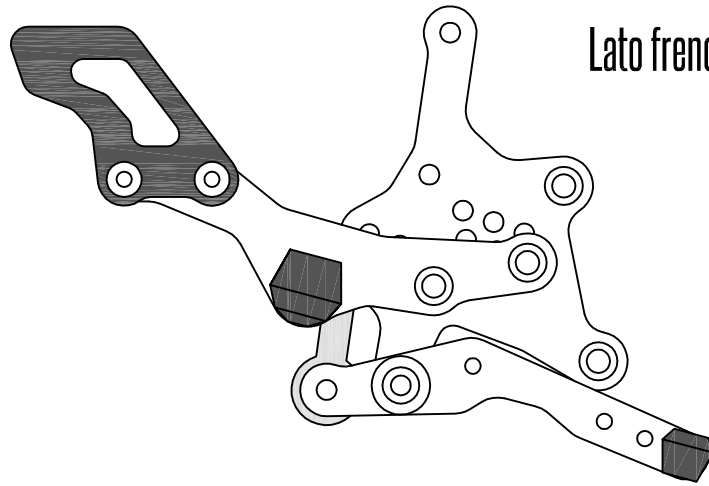

Lato freno - *Brake side*

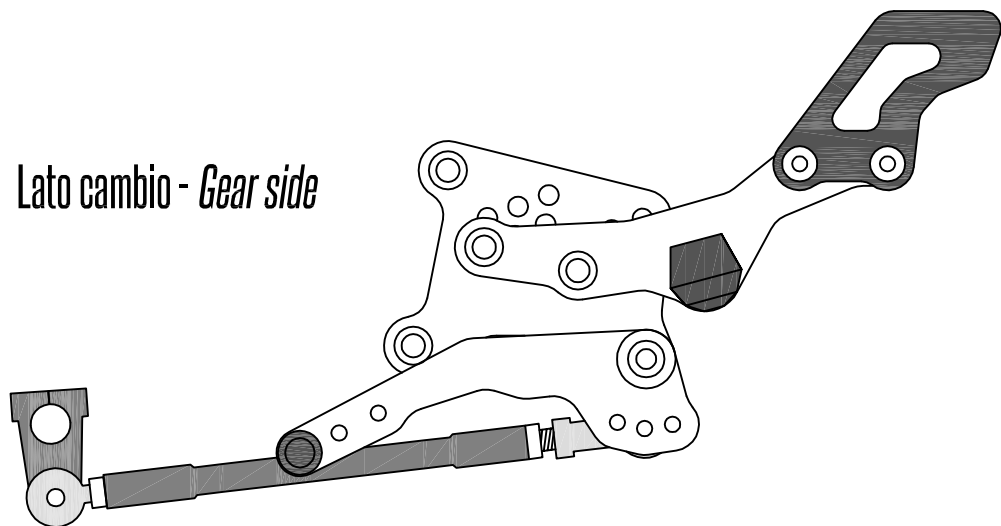

Lato cambio - *Gear side*

GeckoRacing

Kawasaki Zx-6R, Zx-9R (1998-2003)

Bustina 1 - Bag 1

pedali poggiapiede - *footrest pegs*

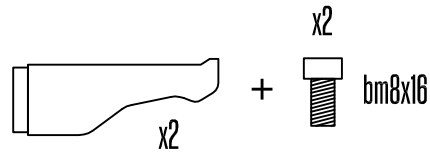

Bustina 2 - Bag 2

pedalini leve - *levers pedals*

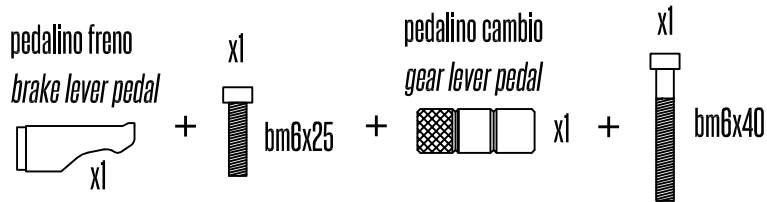

Bustina 3 - Bag 3

paratacchi - *heel guards*

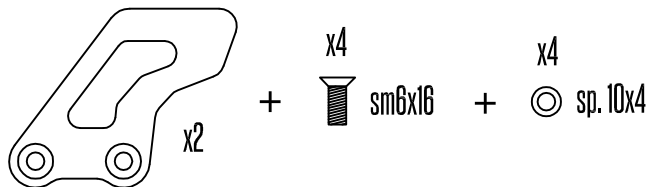

Bustina 4 - Bag 4

telaio - *frame*

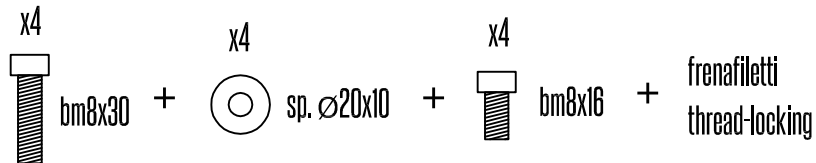

Bustina 5 - Bag 5

pompa olio e cambio - *oil pump and gear*

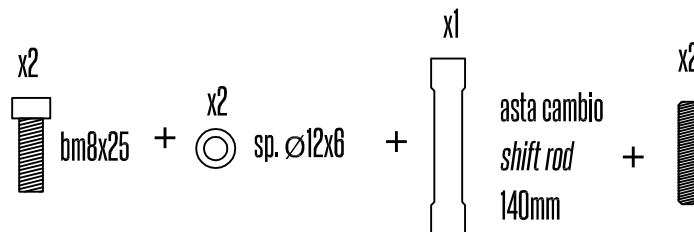

Idrostop

se ordinato - *if ordered*

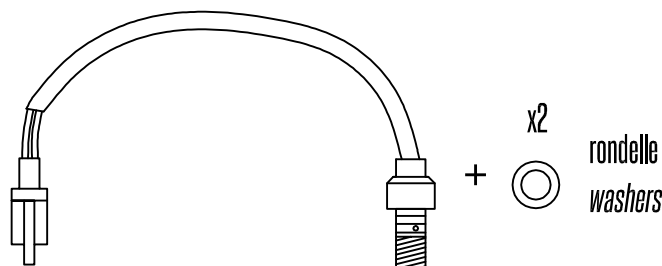

GeckoRacing

Kawasaki Zx-6R, Zx-9R (1998-2003)

bm8x25

+ pompa olio/ *brake pump*

+ sp. $\varnothing 12 \times 6$

+ A

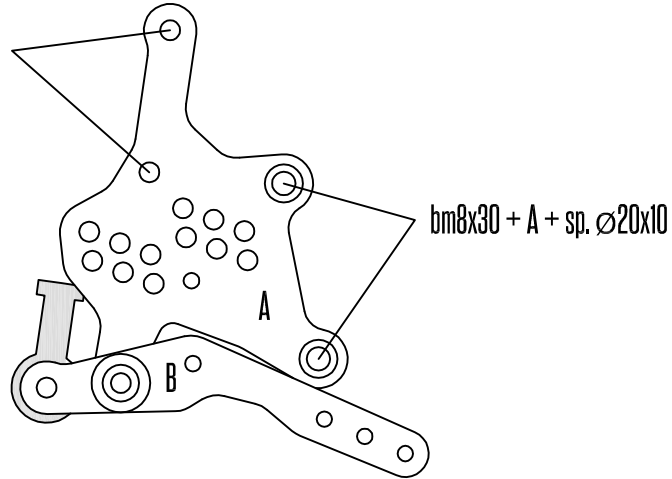

Lato freno - *Brake side*

step 1

bm8x16 + C + A

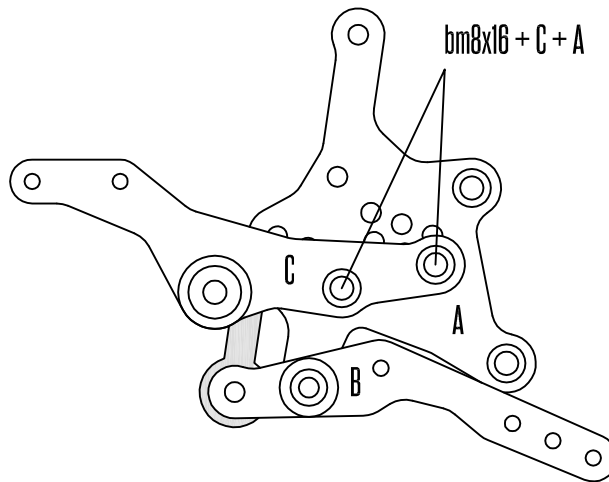

Lato freno - *Brake side*

step 2

sm6x16 + paratacco/ *heel guard* + sp. $\varnothing 10 \times 4$ + C

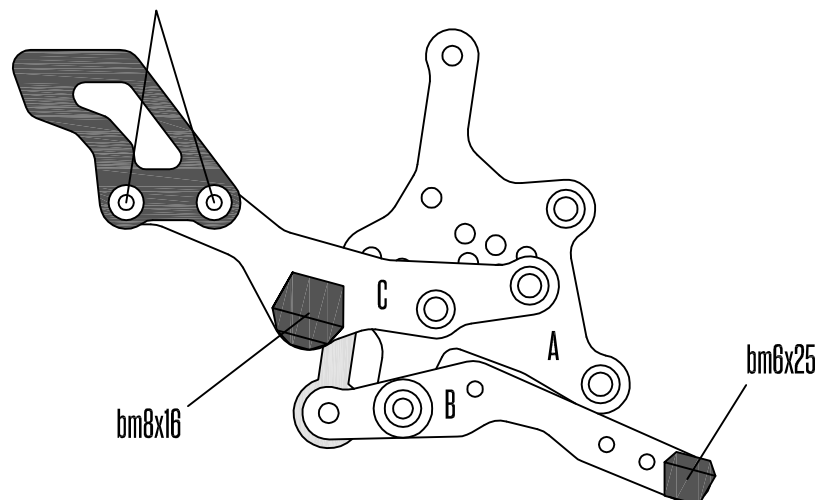

Lato freno - *Brake side*

step 3

Kawasaki Zx-6R, Zx-9R (1998-2003)

Lato cambio - *Gear side*

step 1

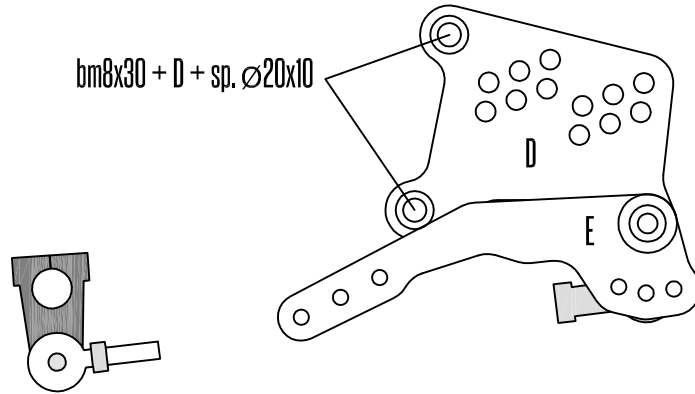

Lato cambio - *Gear side*

step 2

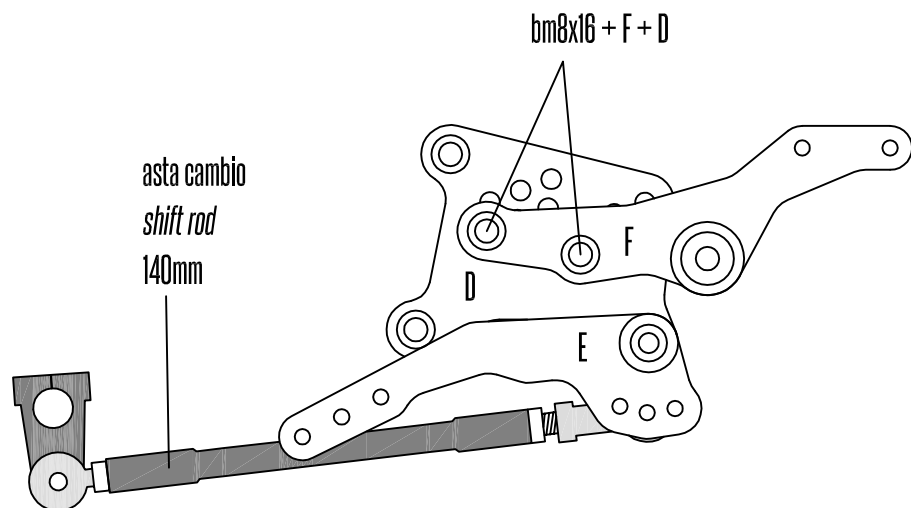

Kawasaki Zx-6R, Zx-9R (1998-2003)

Lato cambio - Gear side

step 3

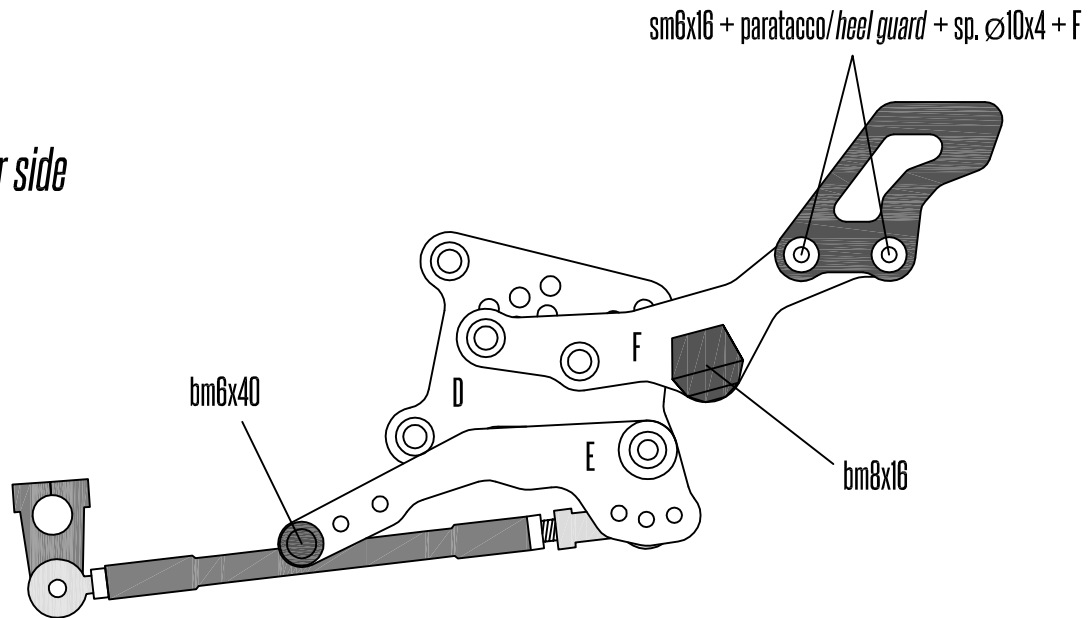

montare il nuovo perno per il cambio rovesciato rivolto verso l'alto
mount the new bracket for reverse gear and turn it upside up

Cambio rovesciato

(se ordinato)

Reverse gear

(if ordered)

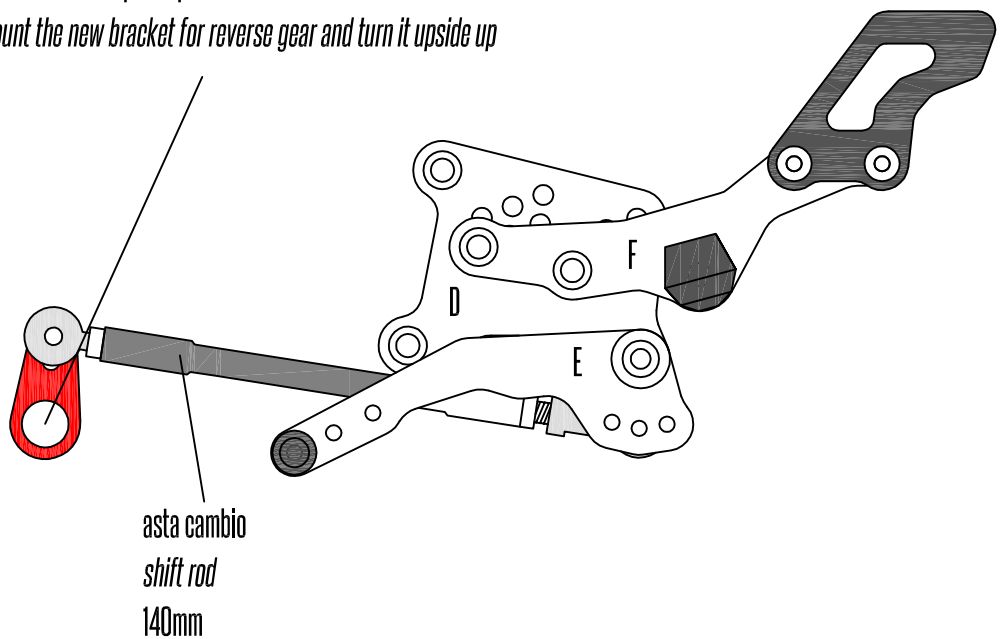

Kawasaki Zx-6R, Zx-9R (1998-2003)

Idrostop

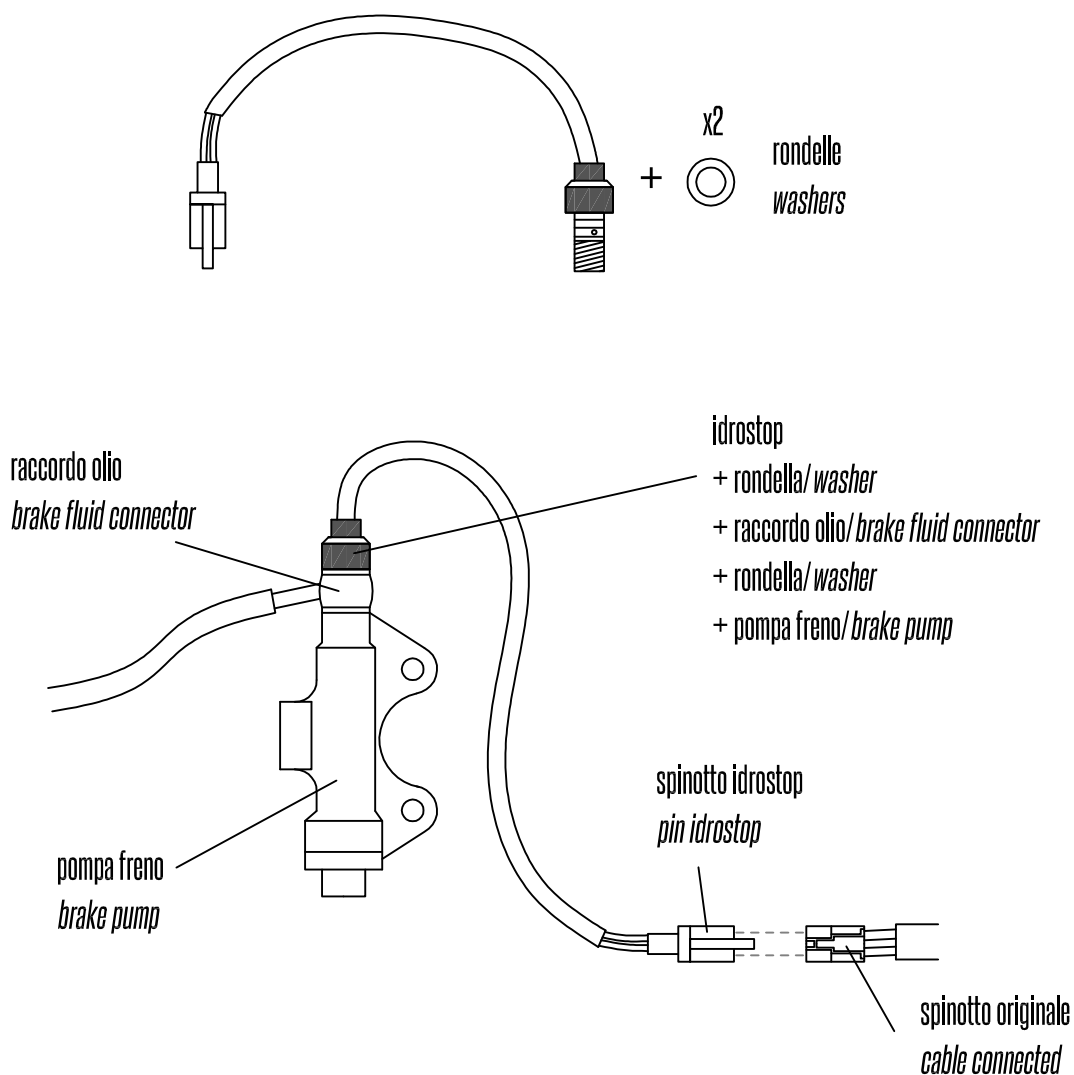

Su alcuni modelli di moto (es: Mt-07 e Hornet >2007) lo spinotto originale è diverso da quello descritto nell'immagine.

Su altri modelli invece il cavo può risultare corto e non permette il collegamento con lo spinotto.

In questi due casi è necessario cablare i fili con l'idrostop per poterlo collegare, oppure usare altri fili come prolungha.

È consigliabile effettuare lo spurgo al termine del montaggio dell'idrostop, ma non è necessario se l'operazione viene effettuata correttamente.

For some models (ex: MT-07, Hornet >2007) the cable connected is different. In these case you need to cable the original one to connect on idrostop.

It's recommended to flush the brake fluid at the end of the idrostop mounting, but it's not necessary if the operation is successful.